



Puppy Jump™

Rev. B

Operations Manual



WARNING

Be sure to read this Operation Manual before using your machine to ensure safe operation.



©2013 Bob's Space Racers Incorporated
427 15th Street, Daytona Beach, Florida 32117
Tel: (386) 677-0761 Fax: (386) 677-0794

Table of Contents

Contents

SPECIFICATIONS	5
Rated power supply:	5
Power consumption:	5
Dimensions:	5
Weight:	5
INTRODUCTION	6
Overview:	6
To Maintain Safety:	6
WARNING: (or) CAUTION:	6
NOTE (or) NOTICE:	6
Important Safety Information:	7
SETUP	7
INSTALLATION	8
Play zone (Operation Zone):	8
Locations to avoid:	8
Game Leveling:	8
CONNECTING THE POWER CORD	9
INSTRUCTION FOR PLAY	10
Basic Game Functions:	10
PROGRAMMING OPTIONS:	11
Explanation Of Programming Values	12
MAINTENANCE AND INSPECTION	12
Maintenance:	13
Cleaning:	13
TROUBLESHOOTING	14
ERROR CODES Displayed on the BONUS SCORE display:	14
SERVICING THE JUMP ASSEMBLY	16
Removing the front Plexiglas	16
Removing the Jump Assembly	17
Adjusting the Toy and Solenoid Heights	19
Adjusting the Solenoid Lift Height	21
Removing the Drive Belt	24
Adjusting the "Trip" Sensor Arm	24
Check hardware for tightness (Monthly Maintenance Check)	25
ELECTRONICS LAYOUT	26
PARTS LIST	27
SCHEMATIC	28
WARRANTY	29

MODEL VIEW



SPECIFICATIONS

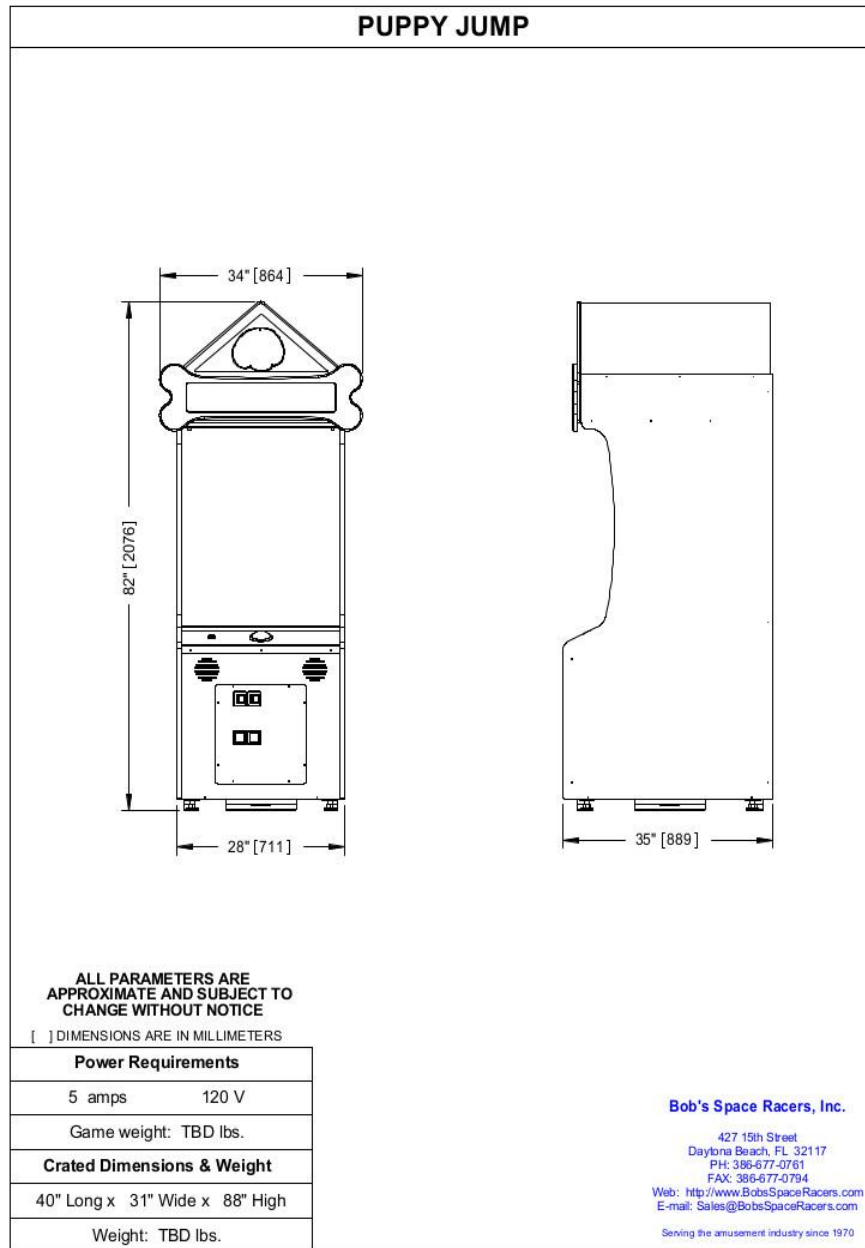

Rated power supply:

120VAC ±5%, 60 Hz.

(Note: Please refer to the label on the game for the actual voltage).

Power consumption:

5Amp 120V

Dimensions:

31" W x 40" D x 88" H

Weight:

350 lbs

NOTE: Game parameters are subject to change without notice.

INTRODUCTION

Overview:

Thank you for purchasing the new PUPPY JUMP™ from Bob's Space Racers®. Built on a long tradition of value, the new PUPPY JUMP™ retains all of the great game play you have come to expect of a game from BSR, and is specifically designed for today's Arcade environment. The new game uses technology specifically developed for this application.

This owner's Manual is intended to provide detailed descriptions together with all the necessary information covering the general operation of electronic assemblies, servicing control, spare parts, etc. pertaining to the game.

This manual is intended for the owner, personnel and managers in charge of operation of the product. Operate the product after carefully reading and sufficiently understanding the instructions. If the product fails to function satisfactorily, non-technical personnel should under no circumstances touch the internal system.

To Maintain Safety:

To ensure the safe usage of the product, be sure to read the following before using the product. The following instructions are intended for the users, operators and the personnel in charge of the operation of the product. After carefully reading and sufficiently understanding the warning display and cautions, handle the product appropriately. Be sure to keep this operation manual nearby the product or elsewhere convenient for referring to it when necessary.

Herein, explanations which require special attention are in sign of warning. Depending on the potentially hazardous degrees, the terms of NOTICE, WARNING, and CAUTION, etc. are used. Be sure to understand the content of the displays before reading the text.

WARNING: (or) CAUTION:

Disregarding this text could result in serious injury or damage to the machine.

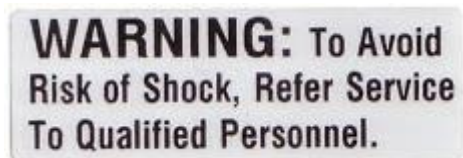

WARNING: To Avoid
Risk of Shock, Refer Service
To Qualified Personnel.



WARNING:
This Part May Have A High Voltage
Present. Disconnect Power From
Equipment Before Servicing.

NOTE (or) NOTICE:

An advisory text to give hints or help.

NOTE: ONLY QUALIFIED TECHNICAL PERSONNEL SHOULD WORK ON THIS GAME. FAILING TO COMPLY CAN CAUSE SEVERE INJURY.

Important Safety Information:**IMPORTANT SAFETY INFORMATION**

WARNING: Unplug the game from the AC wall receptacle when servicing this product. Failure to do so could result in serious injury to yourself or others.

Use only a GROUNDED AC receptacle. Failure to do so could result in improper operation or damage to the game and could void your warranty. If you are unsure that your AC receptacle is properly grounded, have a qualified electrician perform this check for you.

Always be sure power to the game is turned off when doing even routine maintenance. Otherwise, moving parts could activate unexpectedly causing injury.

This product is heavy, necessitated by the design. When moving this game, be sure you have adequate help. Use a suitable dolly or hand truck where practical. Use back support when needed.

SETUP

1. Be sure that the game is on a level surface. If the game is rocking on the floor adjust the legs to remove the rocking of the game.
2. Be sure to plug the game into the proper A.C. GROUNDED receptacle. Do not use long extension cords unless absolutely necessary and if so, be sure it is a heavy duty cord of at least 16 Ga. and no longer than 20 ft. Check the label on the back of the game to make sure the power requirements of the game match that of your location.
3. Turn the game on and check to be sure there are no unusual sounds and that everything appears to be working correctly.

INSTALLATION

ATTENTION

- **For indoor use only!**

Play zone (Operation Zone):

This machine requires space for playing the game. Be sure to leave enough space when installing the machine.

WARNING

- **Be sure to check the Electrical Specifications.** Ensure that this product is compatible with your location's power supply, voltage and frequency requirement. A plate describing Electrical Specifications is attached to the product. Non-compliance with the Electrical Specifications can cause a fire and electric shock.
- Putting many loads on one electrical outlet can cause generation of heat and a fire resulting from overload.

Locations to avoid:

NOTICE

The machine is designed for indoor use only. Never install this machine outdoors or in any of the following:

- Locations exposed to direct sunlight
- Locations subject to rain or water leakage.
- Unstable locations or locations subject to vibration.
- Dusty, hot, or damp locations.

Game Leveling:

Install this machine on a flat surface. Make sure that the machine is level with the floor.

WARNING

- Disconnect game power before moving
- Make sure all wheels are intact. Replace any wheels that are damaged or broken before moving the game.
- When moving the game, DO NOT slide the game across the floor
- Ensure the game is level before connecting the power

CONNECTING THE POWER CORD

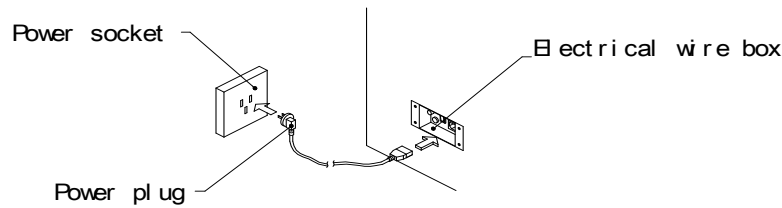

WARNING

- Do not put heavy items on power cord.

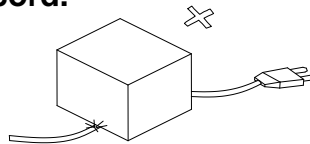

- Hold the power plug instead of the wire to draw the power cord out of the socket.

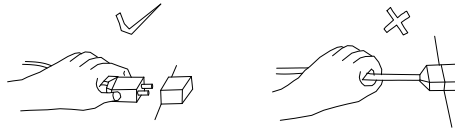

- Do not touch the power plug with wet hands.



- Do not draw or twist the cord or near a heat source.

- Do not place the cord where the player can easily trip over or come in contact with it.



- Operate this game with the correct power and fuse configuration. *(The machine's supply Voltage is 110VAC, please refer to the label on the machine, connect the actual supply voltage, if not, it can cause an electric shock or malfunction.)*

INSTRUCTION FOR PLAY

1. Insert a Coin/Token.
2. Press the PUSH TO START button and wait for the game to start.
3. Press the JUMP button to make the toy jump over the hoop.
4. If the Hoop touches the Toy, the game will end and play a GAME END sound. The player will receive tickets based on their score.

Basic Game Functions:

POWER ON:

Game will perform a P.O.S.T. (*Power On Self Test*)

GAME START:

A player walks up to the game and inserts a coin/token into the coin slot. A sound will be heard so the player knows the game accepted the coin/token. Now the PUSH TO START button will flash along with the LED's in the background. When the player presses the PUSH TO START button, a sound will give directions on how to play the game.

GAME PLAY:

The motor will rotate the hoop around the toy. When the player presses the JUMP button, the toy will be lifted up about 1in via a pinball linear solenoid. The hoop will pass under the toy and the HOME POSITIONING tab will break the IR sensor beam. This will initialize a point increase in the score. After a predetermined amount of jumps (*set by the options setting*) the motor will then increase in speed slightly. This will repeat until the player has touched the hoop with the toy.

GAME OVER:

When the player touches the hoop with the toy, the toy leans forward and a tab that is connected to the right side of the hoop crosses another set of sensor pairs and triggers the end of the game subroutine.

END GAME SUBROUTINE:

Once the player has touched the hoop, the toy will hold its position for 2 seconds and the game will play a sound to encourage the player to play again. Then toy will lift upwards to allow the hoop pass underneath it and the hoop will rotate until its location tab has crossed the IR beam for the positioning sensors. Once it has done this, the tickets will be paid out according to the score and the points per ticket set.

RETURN TO STANDBY MODE:

After the game has completed it will return to STANDBY MODE. During STANDBY MODE, the game will flash the LED's.

BALLY MODE (Option PA):

Depending on the settings in the option register, this mode will flash the attract lights, lift up the toy, spin the hoop around the toy and play music. The options register for bally mode will set whether it's on or off and how often it turns on.

FREE CHANCE (Option P3):

Before the first 5 jumps, a player will receive a certain amount of free chances that are set in the option settings. Once a player has used up, or went over 5 jumps, and hits the hoop, the game will end. This helps a new player to understand how to play the game. This option (P3) is selectable from 1 - 5. We recommend setting this option to at least 3 minimum, with 4 being the BSR default setting.

PROGRAMMING OPTIONS:

BONUS displays, displays the option register (P0, P1, P2, etc)

SCORE display, displays the option value.(1, 2, 3, etc)

ADDRESS	DESCRIPTION	VALUE	DEFAULT
P0	VOLUME	1 – 6	5
P1	COINS PER CREDIT	0 – 10	1
P2	POINTS PER TICKET	0 – 50	4
P3	FREE CHANCE	1 – 5	4
P4	MINIMUM TICKETS	0 – 20	1
P5	MAXIMUM BONUS TICKETS	0 – 250	0
P6	STARTING MOTOR SPEED	0 – 20	10
P7	HIGH SCORE TO BEAT	00 – 99	25
P8	STARTING BONUS TICKET VALUE	00 -99	10
P9	BONUS TICKET VALUE INCREASE	00 – 10	2
PA	BALLY MODE <i>(in seconds x10)</i>	00 – 12	3
Pr	RESET	00 – 01	0

Explanation Of Programming Values

VOLUME	Sound level of speakers
COINS PER CREDIT	How many coins needed to play game
POINTS PER TICKET	Amount of points needed per ticket
FREE CHANCE	See <i>FREE CHANCE</i>
MINIMUM TICKETS	This is the amount of tickets a person will receive in addition to the total ticket payout.
MAXIMUM BONUS TICKETS	Max Total Bonus only tickets received in addition to min tickets and points per ticket.
STARTING MOTOR SPEED	Speed at which the motor will start off.
HIGH SCORE TO BEAT	This sets the high score to beat to win bonus tickets – <i>this does not increase</i> -
STARTING BONUS TICKET VALUE	How many tickets a person will win when they beat the <i>score to beat</i> in addition to minimum tickets and points per ticket but does not go over the <i>maximum bonus tickets</i> .
BONUS VALUE TICKET INCREASE	How many tickets will increase when the <i>score to beat</i> has not been beaten
BALLY MODE (<i>in seconds x10</i>)	Sets the time interval for the bally mode. Setting to “0” turns off bally mode
RESET	Resets options to the default settings.

MAINTENANCE AND INSPECTION

Maintenance:

Due to the design of the machine, very little periodic maintenance is required.

Start the game and verify the correct operation before putting the game into everyday operations.

Clean the surface of the game as needed.

After about a month of game operation, check to be sure all parts are secure and in proper working order.

1. Remove power before servicing game.

To avoid a short circuit, the power must be removed before touching the inside of the game.

2. Choose the appropriate replacement parts.

Using the wrong parts could lead to malfunction or damage to the game and components.

3. Do not substitute or change equipment, without authorization.

Doing so could lead to a short circuit and machine malfunction, or fire.

4. Do not put containers of water, cups or soda cans on the machine. In addition, chemicals or heavy items should not be allowed around the game.

The spill could cause a short circuit. Falling items could injure people or destroy the machine.

Cleaning:

CLEANING - Clean the outer surfaces of the game with a commercial spray type cleaner. DO NOT however, use glass cleaner or commercial sprays on the marquee graphic panel. Use a good quality spray type furniture polish to keep the game looking good.

WARNING

For your safety, and to reduce risk of damage to your game read the Important Safety Information on page 7 before attempting any troubleshooting procedure.

TROUBLESHOOTING PHILOSOPHY

When troubleshooting any product, certain general guidelines should be followed.

1. Always check to be sure that your game is turned on. Be sure that all of the fuses in the game are functional and check to see that the AC voltage is in the proper operating range for your game.
2. Check to be sure that all of the game harnessing is plugged in properly and that all of the pins are firmly seated in the connectors. It is always possible that a harness can be damaged by rough shipping or moving.
3. Check game harnessing to be sure that none of the wires have become or are damaged. Using a handheld multi-meter, check continuity of the wires to make sure they are not broken.
4. Check for obvious damage to the P.C. Boards or electrical components.
5. If you have multiple games or multiple parts on a game, change or exchange the parts and see if the problem goes away or moves to another location. This way you can quickly eliminate certain parts as being the problem with the game.
6. When changing electronic or electrical components, ALWAYS turn off and unplug the game.
7. Check to see that all power supplies are delivering the specified voltages to the P.C. Boards and components as shown in the manual.

TROUBLESHOOTING

ERROR CODES Displayed on the BONUS SCORE display:

EE1	Out of tickets
EE2	HOME switch / motor failure
EE3	LOSE switch fail
EE4	Motor fail
EE5	Solenoid fail

Symptom	Possible Problem	Solution
Sound Problems -No sound -Low Sound -Intermittent Sound	Low Volume Faulty speaker harnessing Faulty speaker Faulty sound board or sound board harnessing Faulty Main P.C. Board	Check Volume Control and adjust as necessary Check connections and/or repair harnessing Check and/or replace speaker Check connections or Replace Sound Board Check and/or repair or replace Main P.C. Board
Game does not take or add money correctly	Coin switch out of adjustment Coin mech dirty or improperly adjusted Faulty Coin switch Faulty coin switch harness or connector Game improperly programmed Faulty Main P.C. Board or component	Re-bend coin switch wire Clean and adjust mech as necessary Check and/or replace switch Check and/or repair harnessing Check programming options and adjust Repair and/or replace Main P.C. board
Ticket Dispenser not working properly, or no tickets being dispensed	No tickets in the game Tickets jammed in dispenser Ticket dispenser sensor blocked with debris Poor connection on the ticket dispenser Game improperly programmed Faulty ticket dispenser Faulty ticket dispenser harnessing Faulty Main P.C. Board	Refill ticket dispenser Clear ticket jam Clean off sensor Check and/or replace connectors Check ticket programming options Replace dispenser Check and/or repair harnessing Replace or repair Main P.C. Board
Game will not start.	Game power off Electrical Power Switch Open Main fuse blown Power Supply problem or failure Faulty P.C. board or component	Check on/off switch and power cord Close Electrical Power Switch Check and/or replace fuse as necessary Check Power Supply output and connections Repair and/or replace main P.C. board
Game stops or is stopped with nothing displayed	The power connector is disconnected. Possible faulty connection or short circuit.	Reconnect the connector securely. Check all circuitry for faulty connections or short circuits.

NOTE: CONTACT YOUR DISTRIBUTOR IF NONE OF THE CASES LISTED IN THIS MANUAL APPLIES TO THE PROBLEM, OR IF THE ACTION LISTED DOES NOT APPEAR TO RESOLVE THE PROBLEM.

SERVICING THE JUMP ASSEMBLY

Removing the front Plexiglas



Fig. 1

1. Remove the Upper and Lower Support Panels by removing the three (3) screws on each panel as shown in Fig.1 & 2.

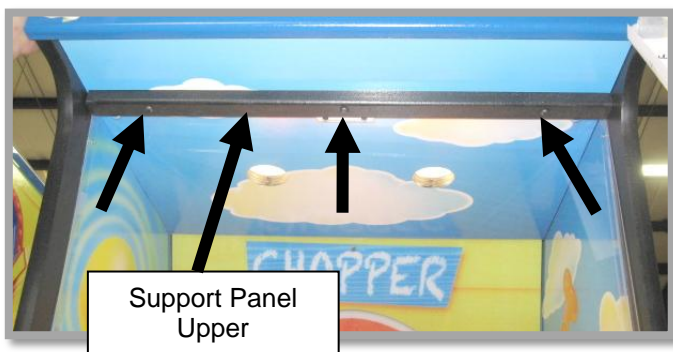

Fig. 2



Fig. 3

2. There are Two (2) holes in the Plexiglas that will aid you in removing the Plexiglas.



Fig. 4

- Carefully twist back the Plexiglas back to remove from cabinet as shown in Fig. 4.

Removing the Jump Assembly

Note: Do Not remove the Jump Assembly if you are just going to make adjustments to the Toy or Solenoid Height. The Jump Assembly and Score Board Plexiglas Must be in place and fastened down to do that (see Adjusting the Toy and Solenoid Heights).



Fig. 5

- Remove the four (4) Screws from the Score Board Plexiglas.



Fig. 6

- Carefully remove the Score Board Plexiglas and set aside.



Fig. 7

3. Remove the 1/4-20 Bolt that is located on the inside rear panel of the Jump Assembly (see Fig. 7).

Sensors / Solenoid Harness Connector

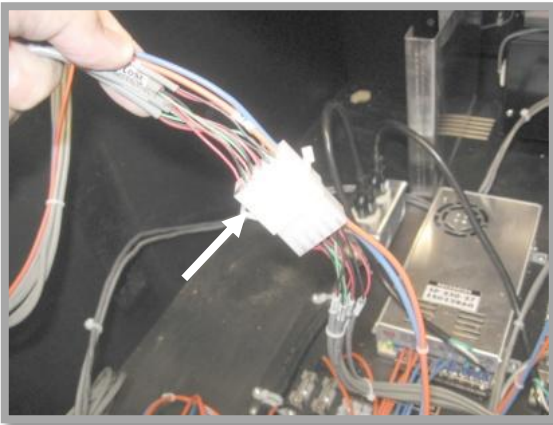

Fig. 8

4. Disconnect the two (2) connectors that are attached to the Jump Assembly as shown in Fig's 8 and 9.

Stepper Motor Power Connector

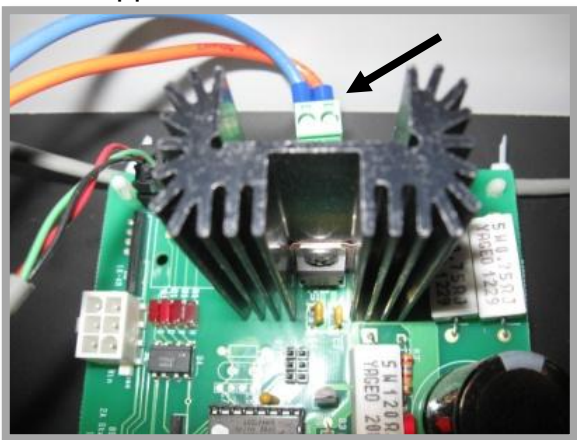

Fig. 9



Fig. 10

5. Securely grab the Jump Assembly by the Horizontal Support Bar with both hands, and pull the Jump Assembly straight up and out slowly, (careful not to scratch decals) as shown in Fig. 10.

Adjusting the Toy and Solenoid Heights

Note: The Jump Assembly must be in the game with the Score Board Plexiglas in place and fastened down before any adjustments can be made to the Toy or Solenoid.



Height Block needed for making adjustments below.

1. Loosen the four (4) 8-32 screws located on the back side of the Toy as shown in Fig. 11.

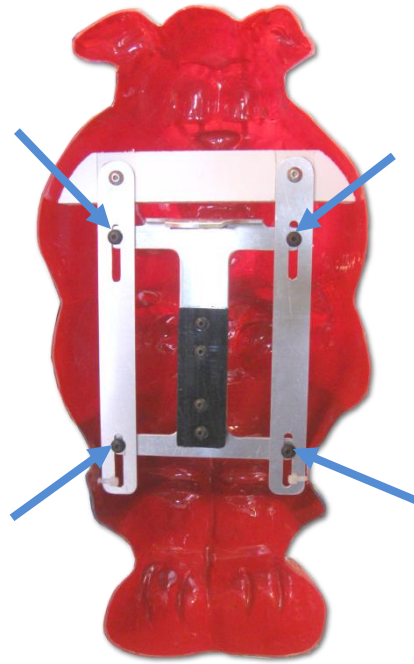

Fig. 11

2. Insert the Height Block labeled "Toy Height Adjustment" under the Toy as shown in Figures 12 & 13.



Fig. 12

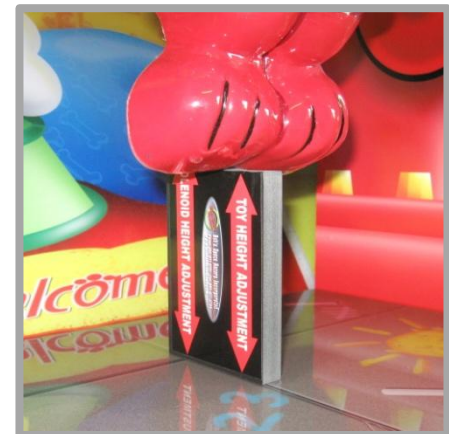

Fig. 13

3. While the Toy is resting on the Height Block, Press down the Lift Bracket until it stops and is resting on the Horizontal Support Bar as shown in Fig. 14.

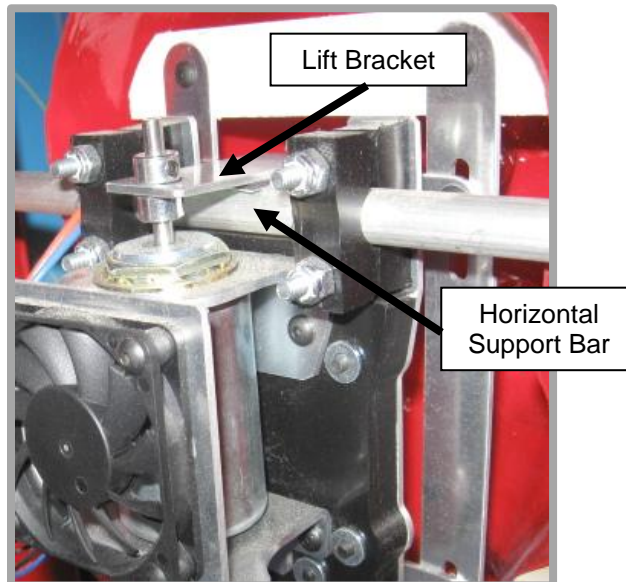

Fig. 14

4. Tighten the four (4) 8-32 screws on the back of the Toy. The Toy is now set to the proper height.
5. Continue to *“Adjusting the Solenoid Lift Height”* below.

Adjusting the Solenoid Lift Height

1. Loosen both Locking Collars on the Solenoid Shaft as shown in Fig. 15.

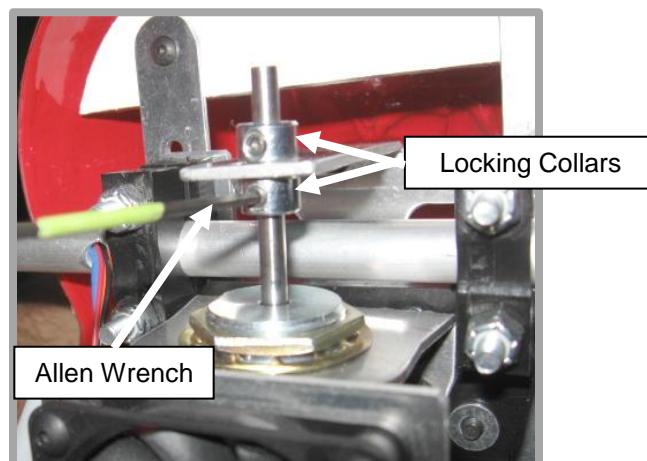

Fig. 15

2. Lift the Toy and place onto the Height Block labeled “Solenoid Height Adjustment” as shown in Fig. 16.



Fig. 16

3. Push the Solenoid Piston up with your finger and move the locking collar to bottom side of the Lift Bracket, and then tighten set screw on collar as shown in Fig. 17.

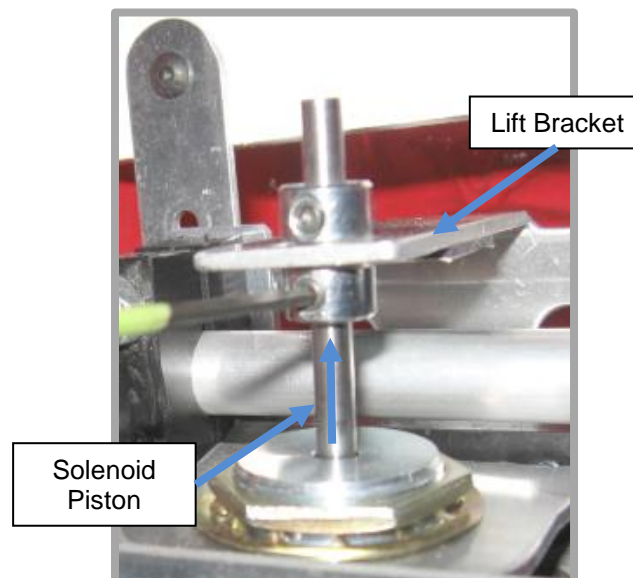

Fig. 17

4. Lock the upper locking collar to the top side of Lift Bracket and tighten set screw on collar as shown in Fig. 18. The Solenoid is now set to the proper height.

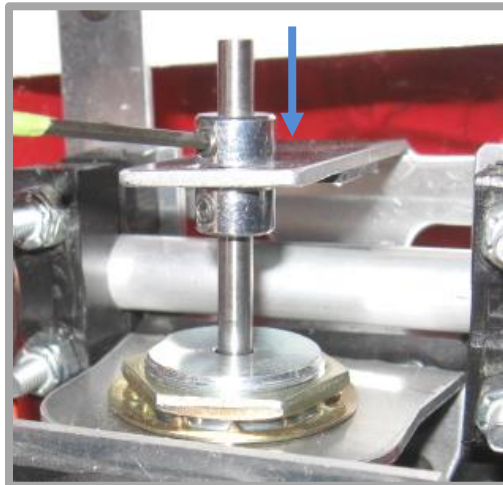

Fig. 18

5. The Toy and Jump Heights are now complete. Play the game and re-adjust if necessary.

Removing the Drive Belt

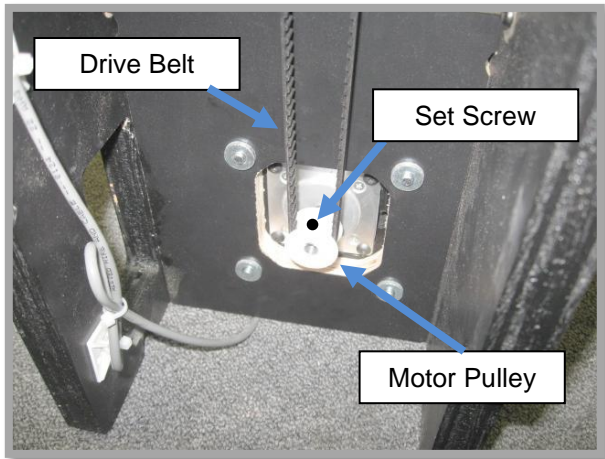

Fig. 19

1. Turn Motor Pulley by hand until Set Screw is visible.
2. Loosen Motor Pulley Set Screw.
3. Pull off Motor Pulley from Motor Shaft.
4. Belt is now free and can be removed from Jump Assembly.
5. Reverse order above for Belt replacement.

Adjusting the "Trip" Sensor Arm

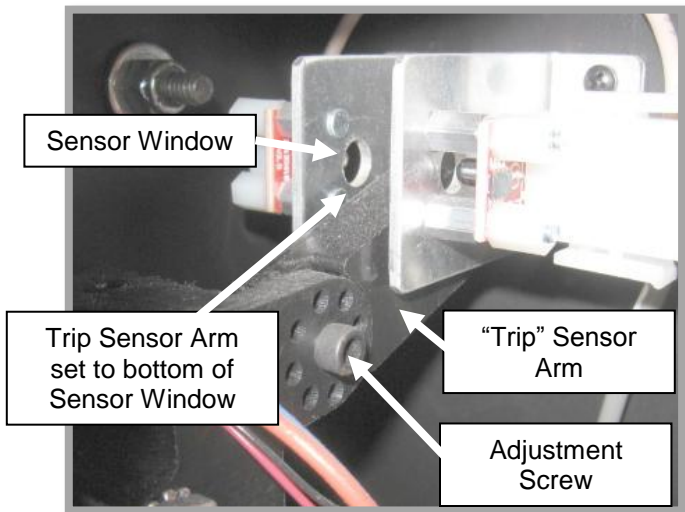

Fig. 20

1. Loosen Swivel Locking Screw.
2. Adjust the "Trip" Sensor Arm so that top edge of the Sensor Arm is at the same level with the lower the lower side of the Sensor Window opening (see fig. 20).
3. Tighten Swivel Locking Screw.

Check hardware for tightness (Monthly Maintenance Check)

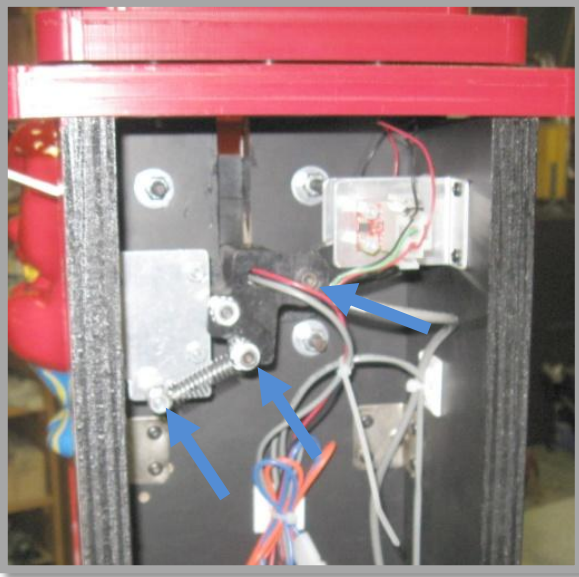

Fig. 21

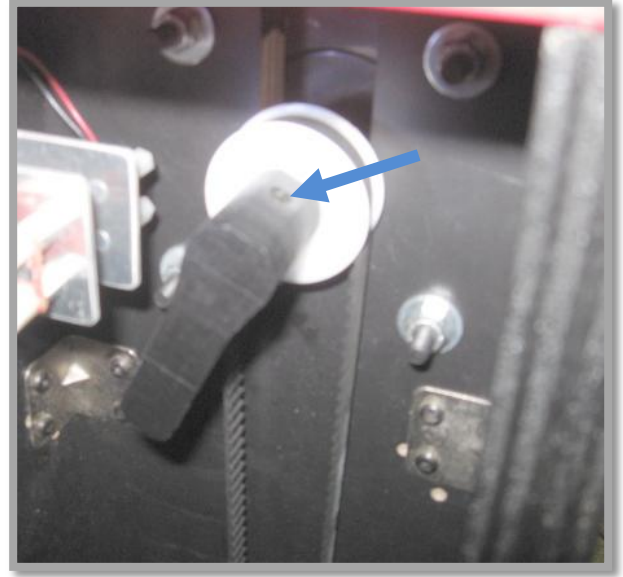

Fig. 22

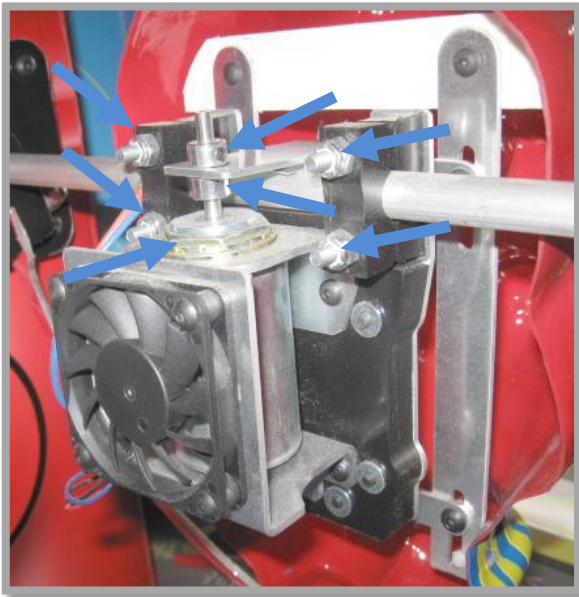

Fig. 23

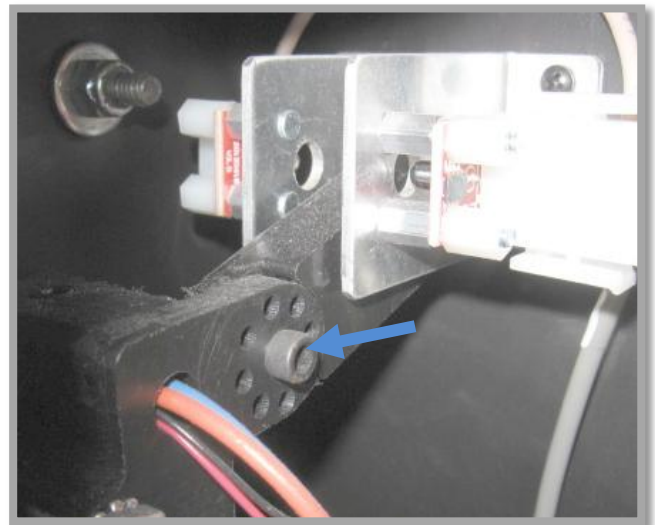

Fig. 24

ELECTRONICS LAYOUT

Main Controller Board

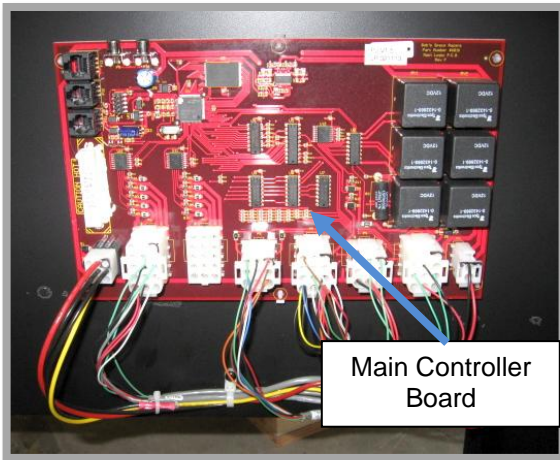

Fig. 25

Power Supply's

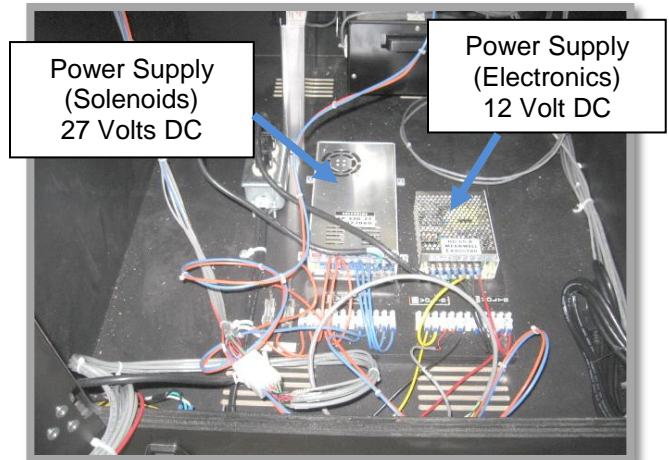

Fig. 26

Ticket Mech / Program Panel

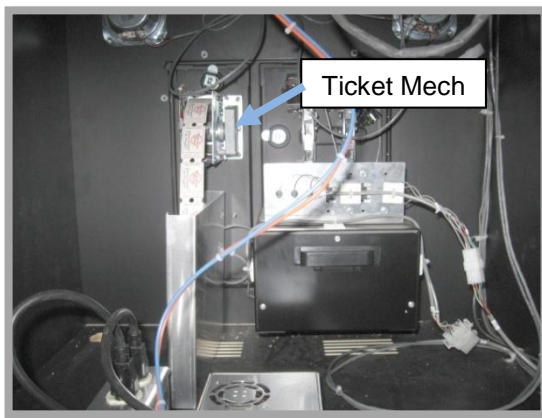

Fig. 27

Coin Mech / Counters

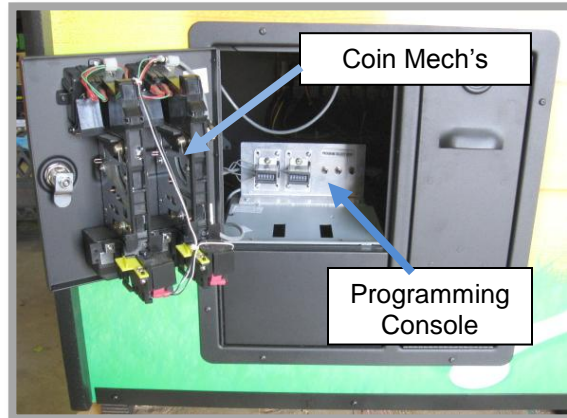

Fig. 28

Jump Box Quick Disconnect

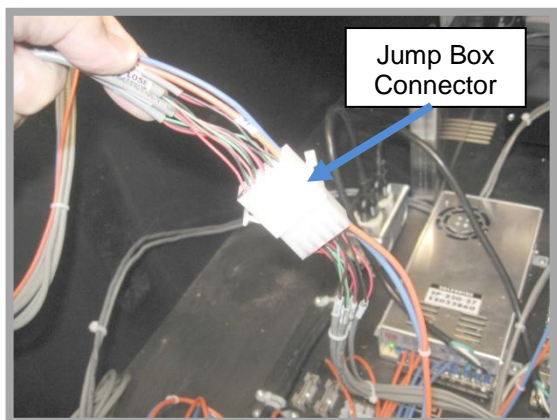

Fig. 29

Solid State Relay / Motor Controller / Stepper Motor

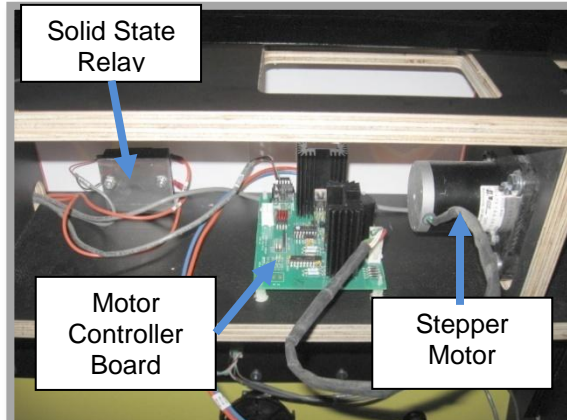
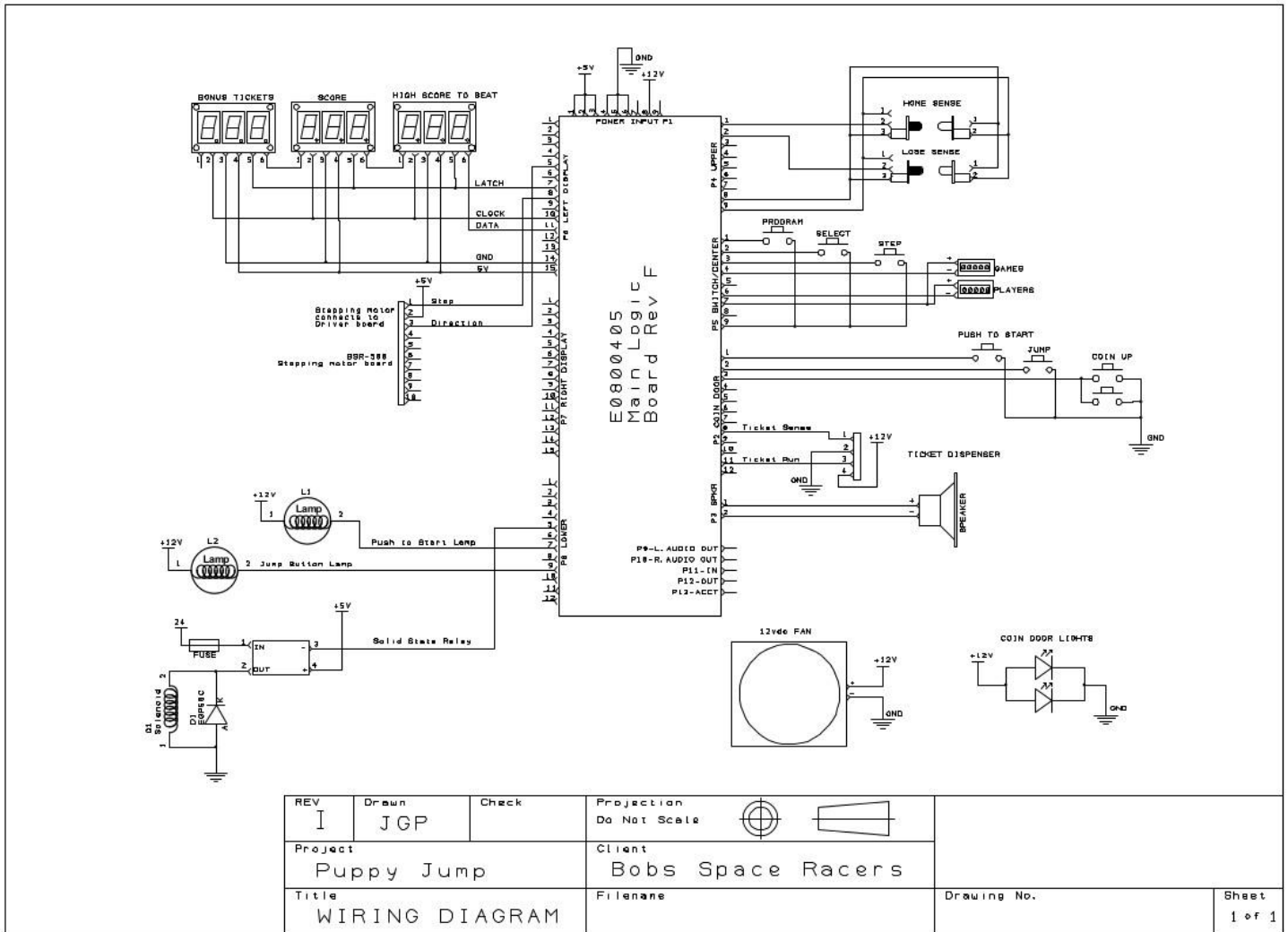

Fig. 30

PARTS LIST

Part Number	Description
E0800405	BOARD-MAIN PC (ROHS)
E0022860	POWER SUPPLY 27VDC 11.7AMP SP-320-27
E0800180	POWER SUPPLY 65WATT MEANWELL DUAL ON-OFF
E0020300	TICKET DISPENSER DELTRONIC 1005 BSR STYL
M0800140	COIN MECH .25/QUARTER PLASTIC 42-3079-00
E0004296	RELAY SOLID STATE 7 AMP 60VDC OUTPUT
EX033484	BOARD-ASSY STEPPING MOTR V II BSR-0500C
E0007680	MOTOR STEPPING HT23-597 NEMA 23
E0020760	SOLENOID LINEAR 24V 1" STROKE
E0800154	SENSOR RECEIVER RX-1 ROHS BLK
E0800165	SENSOR TRANS TX-1B ROHS CLR
H0018519	BELT NEOPRENE 3/8"W X 38"DIA #SX 380XL
EM040744	DISPLAY 3 DIGIT 2"
E0019774	FAN BOX COOLING 60MM CASE 12V
E0027390	E0027390 SPEAKER 4" ROUND MID RANGE 8 OHM

SCHEMATIC



REV I	Drawn JGP	Check	Projection Do Not Scale		
Project Puppy Jump			Client Bobs Space Racers		
Title WIRING DIAGRAM			Filename	Drawing No.	Sheet 1 of 1

WARRANTY

BOB'S SPACE RACERS INC. 90 DAY COIN-OPERATED GAME WARRANTY

1. INCLUDED IN THIS WARRANTY Bob's Space Racers®, Inc. warrants to the original purchaser only that the equipment that is the subject of this sale conforms to its specifications, and is free from defects under normal service for a 90 day period from the original date of deliver. This warranty does not include any damages resulting from occurrences listed in paragraph 2 below. This warranty is not transferable under any circumstance. Any claims under this warranty must be received in writing by Bob's Space Racers®, Inc. within 120 days from date of delivery. Within a reasonable time of such written notification Bob's Space Racers®, Inc. will replace or repair any defective component of the equipment or part thereof which fails for reasons other than normal service, use, or wear. Bob's Space Racers®, Inc. reserves the right to request dated proof of purchase by the end user (original purchaser) at any time. Light bulbs are specifically excluded from this warranty and shall be the sole responsibility of the purchaser. Bob's Space Racers®, Inc., within its sole discretion, makes the final determination as to whether to repair or replace any component and whether any such repair or replacement shall be performed where the equipment is located or at it's home facility in Volusia County, Florida, or another facility of its sole choice. Any and all freight charges for the purposes of repair or replacement shall be paid by the original purchaser. All defective parts shall be returned to Bob's Space Racers®, Inc. if requested. Bob's Space Racers®, Inc. does not warrant that the equipment will meet any original purchaser's specific requirements or that the operation of the equipment will be uninterrupted. These remedies are the original purchaser's exclusive remedies for breach of warranty.

2. EXCLUDED BY THIS WARRANTY Bob's Space Racers®, Inc. does not warrant (a) any product, components or parts not manufactured by Bob's Space Racers®, Inc.; (b) damages caused by use of the equipment for purposes other than those for which it was designed; (c) defects caused by failure to provide a suitable installation environment for the equipment; (d) damage caused by unauthorized attachments, modification, or service; (e) damage caused by normal wear and tear or improper power supply; (f) damage caused by accident or disaster such as fires, flood, lightning, and wind; or (g) any other abuse or misuse of the equipment.

3. EXCLUSIVE WARRANTY. THE FORGOING WARRANTY IS EXCLUSIVE AND IN LIEU OF ALL OTHER WARRANTIES OR REMEDIES, WHETHER WRITTEN, ORAL OR IMPLIED. THERE ARE NO WARRANTIES WHICH EXTEND BEYOND THE DESCRIPTION ON THE FACE HEREOF. ANY AND ALL IMPLIED WARRANTIES OF MERCHANTABILITY, FITNESS FOR A PARTICULAR PURPOSE, COURSE OF DEALING OR USAGE OF TRADE ARE HEREBY EXPRESSLY DISCLAIMED AND EXCLUDED.

4. REMEDIES LIMITED. UNDER NO CIRCUMSTANCES, EXCEPT TO THE EXTENT PROHIBITED BY APPLICABLE LAW, SHALL BOB'S SPACE RACERS®, INC. BE LIABLE FOR ANY LOSS OR DAMAGE, DIRECT OR INDIRECT, SPECIAL INCIDENTAL OR CONSEQUENTIAL ARISING OUT OF THE USE OR INABILITY TO USE THIS EQUIPMENT INCLUDING BUT NOT LIMITED TO ANY CLAIM FOR LOSS OR PROFITS, LOSS OF SAVINGS OR REVENUE, LOSS OF USE OF THE EQUIPMENT, OR ANY ASSOCIATED EQUIPMENT, FACILITIES OR SERVICE, DOWNTIME, THE CLAIMS OR COSTS OF THIRD PARTIES INCLUDING CUSTOMERS AND INJURY TO PROPERTY. Some states do not allow limitations on how long an implied warranty lasts or the exclusion or limitation of incidental or consequential damages, so the above limitations or exclusion may not apply to you. This warranty gives you specific legal rights, and you may also have other rights which vary from state to state.

5. NO OTHER WARRANTIES. Unless modified in writing and signed by both parties, this agreement is understood to be the complete and exclusive agreement between the parties, superseding all prior agreements, oral or written, and all other communications between the parties relating to the subject matter of this agreement. No employee or representative of Bob's Space Racers®, Inc. or any other party is authorized to make any other warranty or to assume any other liability in connection with the sale of its equipment.

6. TIME LIMIT FOR CLAIMS. Any claim for breach of warranty or claims under this warranty must be received in writing by Bob's Space Racers®, Inc. within 120 days following delivery of the equipment.

7. FUTURE CHANGES. Bob's Space Racers®, Inc. reserves the right to reserve, change or modify the construction and design of its equipment or any component part or parts thereof without incurring the obligations to make such changes or modifications in present equipment.

8. ALLOCATION OF RISKS. This agreement allocates the risks of equipment failure between Bob's Space Racers®, Inc. and the original purchaser. This allocation is recognized by both parties and is reflected in the price of the goods. THE PURCHASER ACKNOWLEDGES THAT HE HAS READ THIS AGREEMENT, UNDERSTANDS IT, AND IS BOUND BY ITS TERMS.

9. TO OBTAIN WARRANTY SERVICE. The original purchaser must, at his/her own expense, bring or ship the equipment to an authorized location for service. Additionally, the original purchaser must pay all freight, shipping or transportation charges for the return of the equipment from Bob's Space Racers®, Inc. to the original purchaser. Telephone or write:

Bob's Space Racers®, Inc.
427 15th Street
Daytona Beach, FL 32117
Telephone number: 386/677-0761
FAX: 386/677-0794

CALLING FOR SERVICE

1. When calling for service, please check the service manual first. Many times the answer to your problem has been addressed in this documentation.
2. Please make sure you have the serial number of the game ready when you call.
3. If this is a repeat call, please tell the service technician that you have made a previous call regarding this problem. This way we will be able to retrieve the history on your game allowing us to serve you better and save you time.
4. Please retain proof of purchase for your product. This might be requested for warranty repairs.
5. Please call from the game if possible since we might need you to check certain things on the game while we are on the telephone with you.

IF YOU HAVE ANY QUESTIONS OR COMMENTS, PLEASE CALL OUR SERVICE DEPARTMENT AT

(386) 677-0761

(MONDAY – FRIDAY, 8:30AM – 5:00PM EST, EXCLUDING HOLIDAYS)

(or)

EMAIL QUESTIONS TO: Tech@BobsSpaceRacers.com

(or)

**VISIT THE “CUSTOMER SUPPORT” SECTION ON OUR WEBSITE:
WWW.BOBSSPACERACERS.COM**