



Bazooka Blast™

Rev. A

Installation, Setup and Operations Manual

For 2, 3, & 4 Player Models



WARNING

Be sure to read this Operation Manual before using your machine to ensure safe operation.



©2011 Bob's Space Racers Incorporated

427 15th Street, Daytona Beach, Florida 32117

Tel: (386) 677-0761 Fax: (386) 677-0794

TABLE OF CONTENTS

Contents

SPECIFICATIONS	3
Power consumption:	3
Dimensions:	3
INTRODUCTION	3
Overview:	3
To Maintain Safety:	3
WARNING: (or) CAUTION:	4
NOTE (or) NOTICE:	4
IMPORTANT SAFETY INFORMATION	4
INSTALLATION INSTRUCTIONS.....	5
AIR COMPRESSOR INFORMATION	7
TARGET SETUP	7
INSTRUCTIONS FOR PLAY	8
To Start Game:	8
Relocating the Player Enable Station:	8
MAINTENANCE AND INSPECTION.....	8
Maintenance:	8
Cleaning:.....	9
TROUBLESHOOTING.....	9
Electronics Logic Procedure:.....	10
Player button does not activate the player:	10
Gun does not fire:	10
PARTS LIST	11
SYSTEM LAYOUT.....	13
SCHEMATICS.....	14
WARRANTY	16
CALLING FOR SERVICE.....	17

SPECIFICATIONS

Power consumption:

Game Electronics– 2.5 Amps @ 120 VAC 60Hz.

Air Compressor – 15 Amps @ 120 VAC 60Hz.

Air Compressor – 7.5 Amps @ 240 VAC 60Hz.

Dimensions:

(Footprint)

(2 Player) Depth 10'-1/4", Length 5'-6", Height 7'-1/2"

Weight: 454 lbs.

(3 Player) Depth 10'-1/4", Length 8', Height 7'-1/2"

Weight: 681 lbs.

(4 Player) Depth 10'-1/4", Length 10'-6", Height 7'-1/2"

Weight: 908 lbs.

NOTE: Game parameters are subject to change without notice.

INTRODUCTION

Overview:

Thank you for purchasing the new BAZOOKA BLAST™ from Bob's Space Racers®. Built on a long tradition of value, the new BAZOOKA BLAST™ retains all of the great game play you have come to expect of a game from BSR, and is specifically designed for today's Park game environment. The new game uses technology specifically developed for this application.

This owner's Manual is intended to provide detailed descriptions together with all the necessary information covering the general operation of electronic assemblies, servicing control, spare parts, etc. pertaining to the game.

This manual is intended for the owner, personnel and managers in charge of operation of the product. Operate the product after carefully reading and sufficiently understanding the instructions. If the product fails to function satisfactorily, non-technical personnel should under no circumstances touch the internal system.

To Maintain Safety:

To ensure the safe usage of the product, be sure to read the following before using the product. The following instructions are intended for the users, operators and the personnel in charge of the operation of the product. After carefully reading and sufficiently understanding the warning display and cautions, handle the product appropriately. Be sure to keep this operation manual nearby the product or elsewhere convenient for referring to it when necessary.

Herein, explanations which require special attention are in sign of warning. Depending on the potentially hazardous degrees, the terms of NOTICE, WARNING, and CAUTION, etc. is used. Be sure to understand the content of the displays before reading the text.

WARNING: (or) CAUTION:

Disregarding this text could result in serious injury or damage to the machine.

WARNING: To Avoid
Risk of Shock, Refer Service
To Qualified Personnel.

WARNING:
This Part May Have A High Voltage
Present. Disconnect Power From
Equipment Before Servicing.

NOTE (or) NOTICE:

NOTE: ONLY QUALIFIED TECHNICAL PERSONNEL SHOULD WORK ON THIS GAME. FAILING TO COMPLY CAN CAUSE SEVERE INJURY.

IMPORTANT SAFETY INFORMATION

WARNING: Unplug the game from the AC wall receptacle when servicing this product. Failure to do so could result in serious injury to yourself or others.

Use only a GROUNDED AC receptacle. Failure to do so could result in improper operation or damage to the game and could void your warranty. If you are unsure that your AC receptacle is properly grounded, have a qualified electrician perform this check for you.

Always be sure power to the game is turned off when doing even routine maintenance. Otherwise, moving parts could activate unexpectedly causing injury.

This product is heavy, necessitated by the design. When moving this game, be sure you have adequate moving equipment and help. Use back support when needed.

INSTALLATION INSTRUCTIONS

Game Layout



FIG. 1

1. Target Box
2. Gun Counter *(Plain Laminate is Standard)*
3. Cable Cover
4. Seat Assembly
5. Marquee Sign *(Optional Low Profile Marquee Sign shown above)*

Instructions for Assembly

1. Place Target Box on clean level floor.
2. Set Gun Counter approximately 42" in front of Target Box as shown in Fig.4.
3. Install "Bottom" Cable Cover Board between the Gun Counter and the Target Box as shown in Fig. 4.
4. Run Power Cable and Air Line Hose from the Gun Counter to the Target Box by inserting them through the Cable Cutout Channel as shown in Fig. 3.
5. Run Target Rope Light Cable from the Target Box (Fig. 5) to the Gun Counter and connect the two connectors shown in Fig. 6.
6. Install the "Top" Cable Cover as shown in Fig. 4
7. Install Seats.
8. Attach Air line to Air compressor.
9. Set air compressor pressure between 50-60 PSI.
10. Set Surge Tank pressure to 60 PSI for each player as shown in Fig. 7.

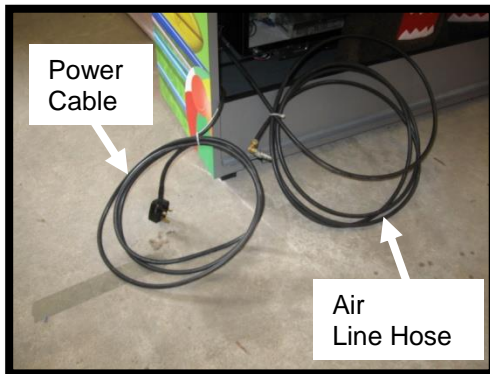

Fig. 2

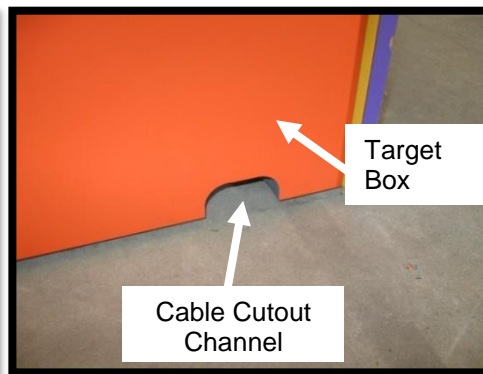

Fig. 3

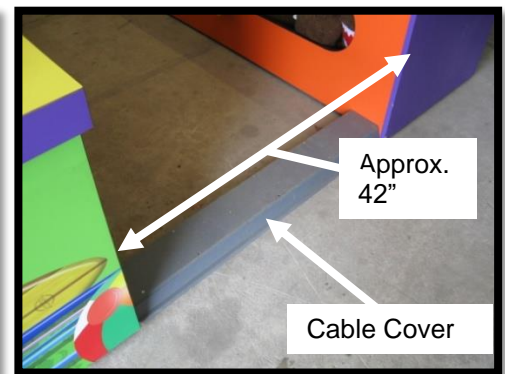

Fig. 4



Fig. 5

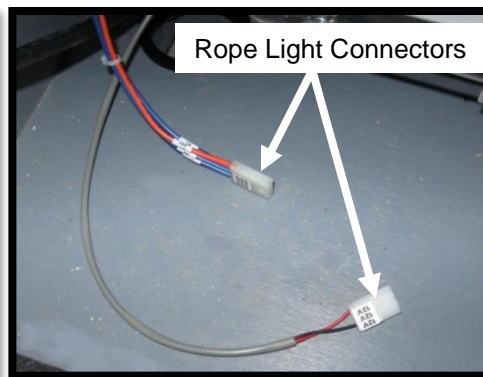

Fig. 6

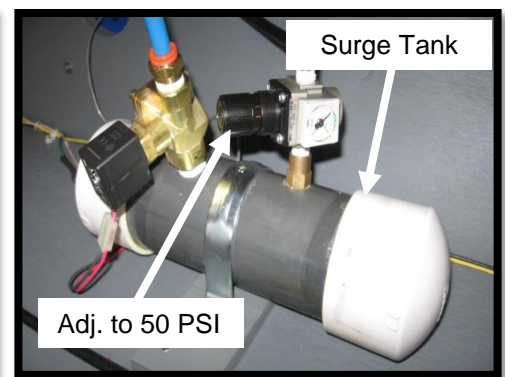

Fig. 7

AIR COMPRESSOR INFORMATION

Recommended Air Compressor for the Bazooka Blast Game



Kobalt - Model's VT63 Series
(BSR Recommended)

30 - 60 Gallon Air Compressor

- 5.5 – 11.5 CFM @ 90 P.S.I.
- 6.5 – 13.4 CFM @ 40 P.S.I.
- 2.0 – 4.0 HP
- 30 - 60 Gallon Tank
- 150 Maximum P.S.I.
- 120 – 240 VAC
- 15 Amps Draw

TARGET SETUP

Game comes with 6 metal Cylinders per player. Arrange and stack all Cylinders as shown in Fig. 8 & 9.



Fig. 8

Arrange Cylinders as shown for each player



Fig. 9

Stack Cylinders as shown for each player

INSTRUCTIONS FOR PLAY



Player Enable Station
(Located under Gun Counter)

To Start Game:

- Attendant will press the player enable button for that player. Player ID light will turn on.
- Player presses the fire button.
- Bazooka fires.
- Attendant re-stacks the cylinders to prepare for the next player.



Press Button to Fire Projectile

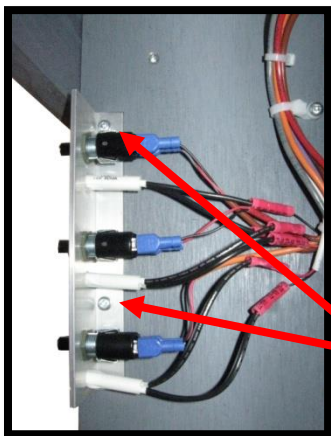

Back Side Fasteners

Relocating the Player Enable Station (PES):

The Player Enable Station can be easily relocated by removing the two (2) wood fasteners as shown.

Remove
fasteners to
relocate.

PES Harness
Assembly

Disconnect the PES Assembly
by rotating the mating connector
counter-clockwise.

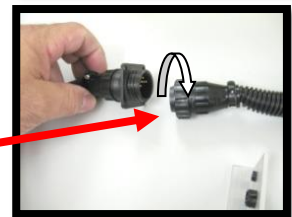
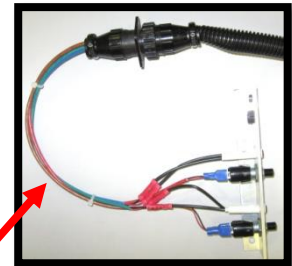

PES Harness and Plug Assembly

MAINTENANCE AND INSPECTION

Maintenance:

Due to the design of the machine, very little periodic maintenance is required.

Start the game and verify the correct operation before putting the game into everyday operations.

Clean the surface of the game as needed.

After about a month of game operation, check to be sure all parts are secure and in proper working order.

1. Remove power before servicing game.

To avoid a short circuit, the power must be removed before touching the inside of the game.

2. Choose the appropriate replacement parts.

Using the wrong parts could lead to malfunction or damage to the game and components.

3. Do not substitute or change equipment, without authorization.

Doing so could lead to a short circuit and machine malfunction, or fire.

4. Do not put containers of water, cups or soda cans on the machine. In addition, chemicals or heavy items should not be allowed around the game.

The spill could cause a short circuit. Falling items could injure people or destroy the machine.

Cleaning:

CLEANING - Clean the outer surfaces of the game with a commercial spray type cleaner. DO NOT however, use glass cleaner or commercial sprays on the marquee graphic panel. Use a good quality spray type furniture polish to keep the game looking good.

TROUBLESHOOTING**WARNING**

For your safety, and to reduce risk of damage to your game read the Important Safety Information before attempting any troubleshooting procedure.

TROUBLESHOOTING PHILOSOPHY

When troubleshooting any product, certain general guidelines should be followed.

1. Always check to be sure that your game is turned on. Be sure that all of the fuses in the game are functional and check to see that the AC voltage is in the proper operating range for your game.
2. Check to be sure that all of the game harnessing is plugged in properly and that all of the pins are firmly seated in the connectors. It is always possible that a harness can be damaged by rough shipping or moving.
3. Check game harnessing to be sure that none of the wires have become or are damaged. Using a handheld multi-meter, check continuity of the wires to make sure they are not broken.
4. Check for obvious damage to the P.C. Boards or electrical components.
5. If you have multiple games or multiple parts on a game, change or exchange the parts and see if the problem goes away or moves to another location. This way you can quickly eliminate certain parts as being the problem with the game.
6. When changing electronic or electrical components, ALWAYS turn off and unplug the game.
7. Check to see that all power supplies are delivering the specified voltages to the P.C. Boards and components as shown in the manual.

General Troubleshooting:

Electronics Logic Procedure:

- When the player enable button is pressed,
 - The ID light turns on
 - Energizes the Common side of the relay for that player
- When the player presses the fire button,
 - The relay closes the circuit
 - Fires the Bazooka
 - Sends a signal to the main control board (MCB)
 - Locks out the player from firing Bazooka again

Player button does not activate the player:

- If only 1 player enable button is working,
 - Test button (does it open and close the circuit when pressed?)
 - Check connectivity of the wires from the button to the MCB
- If all player buttons are not working,
 - Check for AC power to the control box
 - Check for 12Volts DC at the Main Control Board (MCB)

Gun does not fire:

- If only 1 player does not fire,
 - Is the player enabling button working?
 - Does the fire button switch close the circuit when pressed?
 - Is there connectivity from the button switch to the relay board for the player?
 - Check for 12vdc on the valve.
 - Is the air compressor turned on and set between 50-60 PSI?

For further assistance, please call tech BSR Tech Support at 386-676-0761

NOTE: CONTACT YOUR DISTRIBUTOR IF NONE OF THE CASES LISTED IN THIS MANUAL APPLIES TO THE PROBLEM, OR IF THE ACTION LISTED DOES NOT APPEAR TO RESOLVE THE PROBLEM.

PARTS LIST

Part Number	Description
EX033531	Master Board SMART 5Bit SPI I/O - 1x master board (1 for every 3 players) Software Version : BAZOOKA V.04
EX033531	Flasher Board SMART 5Bit SPI I/O - 1x flasher board (1 for every 4 players) Software Version : BAZOOKA_TRI_TARGET_V02
EX033631	Relay Board (Quad) BSR-1100 - 1x (1 for every 4 players)
EX033454	Relay Board (Single) BSR-2481A - 1x (1 for every player)
EX022720	Power Supply 12 Volt DC, 12.5 Amps, SP-150-12
EX022860	Power Supply 27 Volt DC, 11.7 Amps, SP-320-27
E0019780	Fan Boxer, 4", 110 VAC
E0012900	Switch Push Button, N.O., 8411K11
E0029800	ID Light ID Light, 12VDC, Amber
E0050301-RED	Rope Light LED Rope Light X-EON, Red, 24 Volt

Parts List Cont'd

Part Number	Description
E0050235	<p style="text-align: center;">LED Light</p> <p style="text-align: center;">LED Dimmable Warm White, 12 VDC, 16'4" Reel</p>
N0002451	<p style="text-align: center;">Solenoid Air Valve</p> <p style="text-align: center;">½" w/Grommet</p>
N0002715	<p style="text-align: center;">Air Pressure Regulator</p> <p style="text-align: center;">¼" NPT, MOD Regulator w/ Gauge</p>
P0007590	<p style="text-align: center;">Check Valve</p> <p style="text-align: center;">¼", Compact, MNPT/FNPT</p>
MX004530	<p style="text-align: center;">Bazooka Gun Projectile</p>
MX004535	<p style="text-align: center;">Bazooka Target Cylinder</p>
MX004540	<p style="text-align: center;">Bazooka Target Sign Plexiglas Cover</p>

SYSTEM LAYOUT

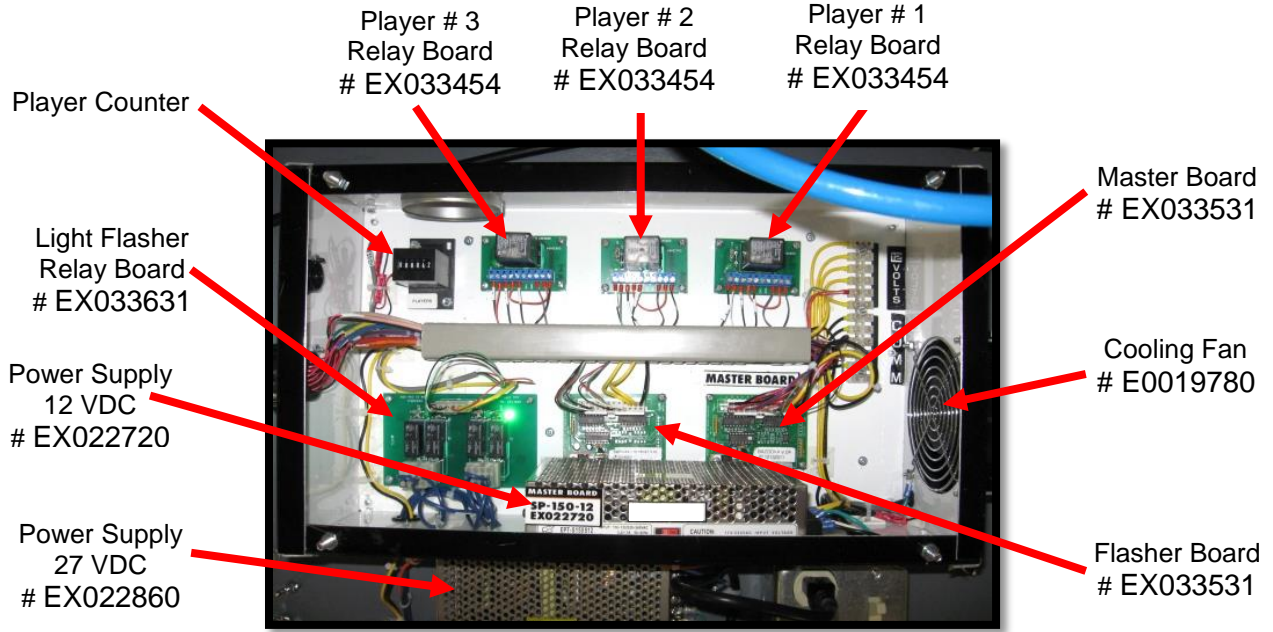

Main Control Box

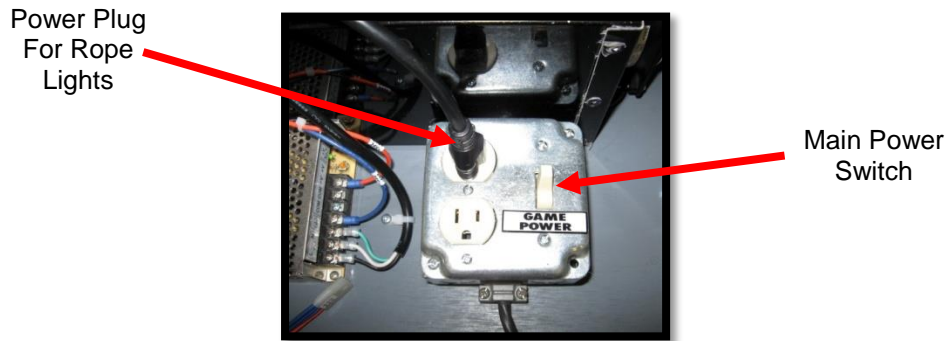

Main Power Switch

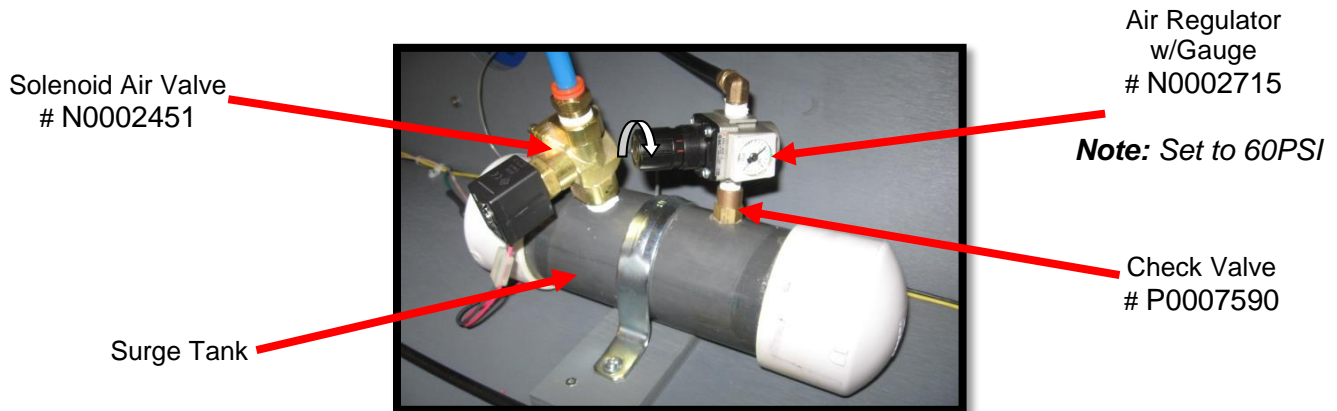

Player Surge Air Tank

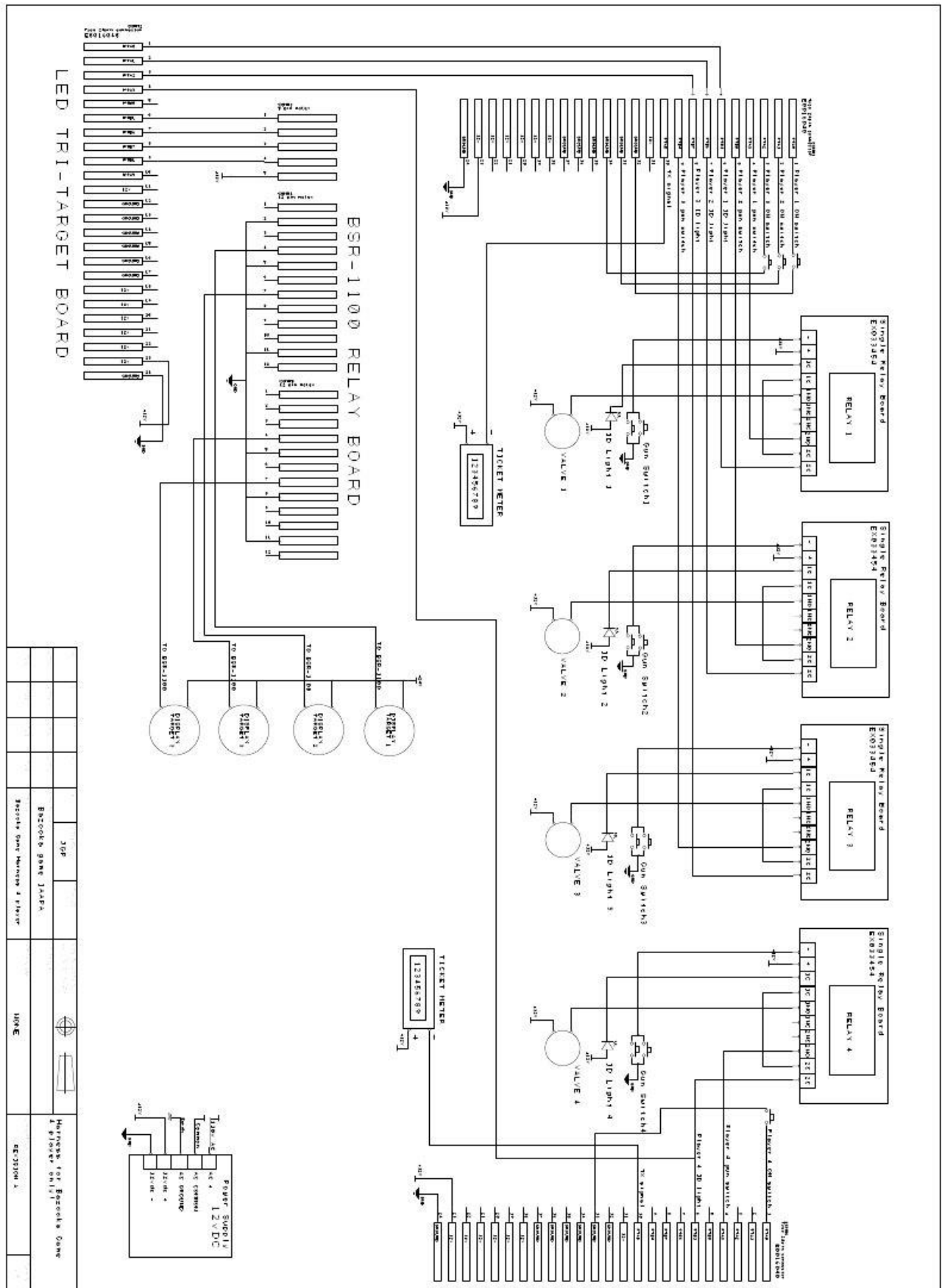

(4 Player)

WARRANTY

BOB'S SPACE RACERS INC. 90 DAY WARRANTY

1. INCLUDED IN THIS WARRANTY Bob's Space Racers®, Inc. warrants to the original purchaser only that the equipment that is the subject of this sale conforms to its specifications, and is free from defects under normal service for a 90 day period from the original date of deliver. This warranty does not include any damages resulting from occurrences listed in paragraph 2 below. This warranty is not transferable under any circumstance. Any claims under this warranty must be received in writing by Bob's Space Racers®, Inc. within 120 days from date of delivery. Within a reasonable time of such written notification Bob's Space Racers®, Inc. will replace or repair any defective component of the equipment or part thereof which fails for reasons other than normal service, use, or wear. Bob's Space Racers®, Inc. reserves the right to request dated proof of purchase by the end user (original purchaser) at any time. Light bulbs are specifically excluded from this warranty and shall be the sole responsibility of the purchaser. Bob's Space Racers®, Inc., within its sole discretion, makes the final determination as to whether to repair or replace any component and whether any such repair or replacement shall be performed where the equipment is located or at it's home facility in Volusia County, Florida, or another facility of its sole choice. Any and all freight charges for the purposes of repair or replacement shall be paid by the original purchaser. All defective parts shall be returned to Bob's Space Racers®, Inc. if requested. Bob's Space Racers®, Inc. does not warrant that the equipment will meet any original purchaser's specific requirements or that the operation of the equipment will be uninterrupted. These remedies are the original purchaser's exclusive remedies for breach of warranty.

2. EXCLUDED BY THIS WARRANTY Bob's Space Racers®, Inc. does not warrant (a) any product, components or parts not manufactured by Bob's Space Racers®, Inc.; (b) damages caused by use of the equipment for purposes other than those for which it was designed; (c) defects caused by failure to provide a suitable installation environment for the equipment; (d) damage caused by unauthorized attachments, modification, or service; (e) damage caused by normal wear and tear or improper power supply; (f) damage caused by accident or disaster such as fires, flood, lightning, and wind; or (g) any other abuse or misuse of the equipment.

3. EXCLUSIVE WARRANTY. THE FORGOING WARRANTY IS EXCLUSIVE AND IN LIEU OF ALL OTHER WARRANTIES OR REMEDIES, WHETHER WRITTEN, ORAL OR IMPLIED. THERE ARE NO WARRANTIES WHICH EXTEND BEYOND THE DESCRIPTION ON THE FACE HEREOF. ANY AND ALL IMPLIED WARRANTIES OF MERCHANTABILITY, FITNESS FOR A PARTICULAR PURPOSE, COURSE OF DEALING OR USAGE OF TRADE ARE HEREBY EXPRESSLY DISCLAIMED AND EXCLUDED.

4. REMEDIES LIMITED. UNDER NO CIRCUMSTANCES, EXCEPT TO THE EXTENT PROHIBITED BY APPLICABLE LAW, SHALL BOB'S SPACE RACERS®, INC. BE LIABLE FOR ANY LOSS OR DAMAGE, DIRECT OR INDIRECT, SPECIAL INCIDENTAL OR CONSEQUENTIAL ARISING OUT OF THE USE OR INABILITY TO USE THIS EQUIPMENT INCLUDING BUT NOT LIMITED TO ANY CLAIM FOR LOSS OR PROFITS, LOSS OF SAVINGS OR REVENUE, LOSS OF USE OF THE EQUIPMENT, OR ANY ASSOCIATED EQUIPMENT, FACILITIES OR SERVICE, DOWNTIME, THE CLAIMS OR COSTS OF THIRD PARTIES INCLUDING CUSTOMERS AND INJURY TO PROPERTY. Some states do not allow limitations on how long an implied warranty lasts or the exclusion or limitation of incidental or consequential damages, so the above limitations or exclusion may not apply to you. This warranty gives you specific legal rights, and you may also have other rights which vary from state to state.

5. NO OTHER WARRANTIES. Unless modified in writing and signed by both parties, this agreement is understood to be the complete and exclusive agreement between the parties, superseding all prior agreements, oral or written, and all other communications between the parties relating to the subject matter of this agreement. No employee or representative of Bob's Space Racers®, Inc. or any other party is authorized to make any other warranty or to assume any other liability in connection with the sale of its equipment.

6. TIME LIMIT FOR CLAIMS. Any claim for breach of warranty or claims under this warranty must be received in writing by Bob's Space Racers®, Inc. within 120 days following delivery of the equipment.

7. FUTURE CHANGES. Bob's Space Racers®, Inc. reserves the right to reserve, change or modify the construction and design of its equipment or any component part or parts thereof without incurring the obligations to make such changes or modifications in present equipment.

8. ALLOCATION OF RISKS. This agreement allocates the risks of equipment failure between Bob's Space Racers®, Inc. and the original purchaser. This allocation is recognized by both parties and is reflected in the price of the goods. THE PURCHASER ACKNOWLEDGES THAT HE HAS READ THIS AGREEMENT, UNDERSTANDS IT, AND IS BOUND BY ITS TERMS.

9. TO OBTAIN WARRANTY SERVICE. The original purchaser must, at his/her own expense, bring or ship the equipment to an authorized location for service. Additionally, the original purchaser must pay all freight, shipping or transportation charges for the return of the equipment from Bob's Space Racers®, Inc. to the original purchaser. Telephone or write:

Bob's Space Racers®, Inc.
427 15th Street
Daytona Beach, FL 32117
Telephone number: 386/677-0761
FAX: 386/677-0794

CALLING FOR SERVICE

1. When calling for service, please check the service manual first. Many times the answer to your problem has been addressed in this documentation.
2. Please make sure you have the serial number of the game ready when you call.
3. If this is a repeat call, please tell the service technician that you have made a previous call regarding this problem. This way we will be able to retrieve the history on your game allowing us to serve you better and save you time.
4. Please retain proof of purchase for your product. This might be requested for warranty repairs.
5. Please call from the game if possible since we might need you to check certain things on the game while we are on the telephone with you.

IF YOU HAVE ANY QUESTIONS OR COMMENTS, PLEASE CALL OUR SERVICE
DEPARTMENT AT

(386) 677-0761

(MONDAY – FRIDAY, 8:30AM – 5:00PM EST, EXCLUDING HOLIDAYS)

(or)

EMAIL QUESTIONS TO: Tech@BobsSpaceRacers.com

(or)

**VISIT THE “CUSTOMER SUPPORT” SECTION ON OUR WEBSITE:
WWW.BOBSSPACERACERS.COM**

REVISION INFORMATION

Revision Letter	Revision Date	Description of Revision Changes
A	02-20-13	- First draft document: No changes as of this date